

RUGBYSAFE ESSENTIAL GUIDES & TEMPLATES

2023/24



WWW.ENGLANDRUGBY.COM

INTRODUCTION TO RUGBYSAFE

RugbySafe, supported by Simplyhealth, is the RFU's overarching player safety and wellbeing programme, putting player welfare at the heart of the game and covering how the game should be organised and managed to provide a safe and enjoyable playing environment.

Within the RugbySafe 'umbrella' there are a number of different initiatives and programmes, all of which play a part in improving and developing awareness of player welfare.

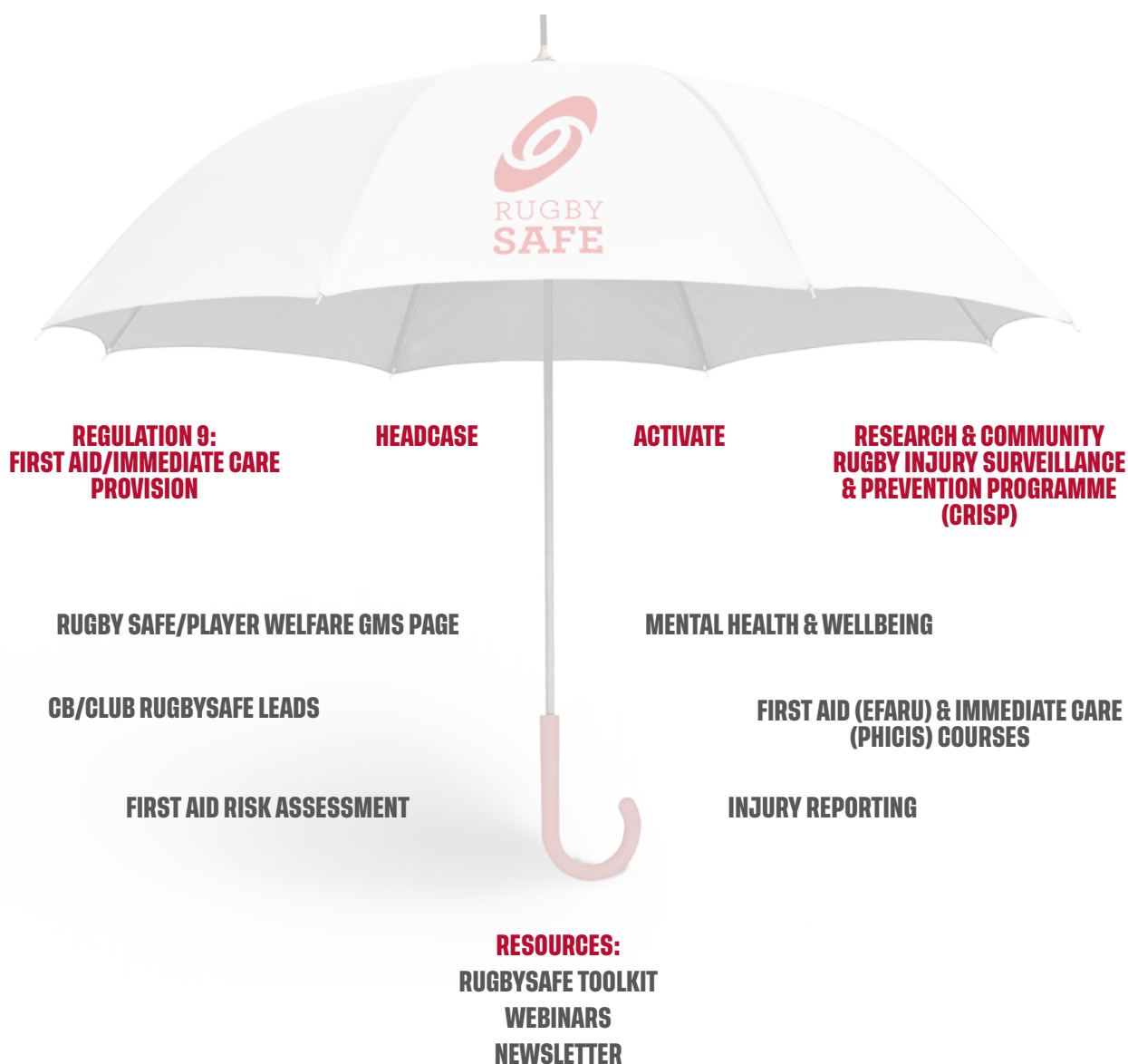

RUGBYSAFE TOOLKIT

This document is part of the RugbySafe Toolkit, a series of digital resources designed to provide information and guidance on the different topics and programmes covering player welfare in rugby union.

- > A Guide to Being RugbySafe
- > Community Rugby Pitch-side First Aid and Immediate Care Provision Guidelines
- > Emergency First Aid and Immediate Care Training
- > HEADCASE
- > Activate
- > Mental Wellbeing
- > Research

To access the different sections in the Toolkit please visit the [RugbySafe home page](#).

CONTENTS

5	SECTION 1:	CLOTHING & EQUIPMENT
19	SECTION 2:	FIRST AID PROVISION
31	SECTION 3:	MEDICAL CONDITIONS & GUIDANCE
51	SECTION 4:	FORMS & TEMPLATES
60	SECTION 5:	USEFUL LINKS

THIS IS AN INTERACTIVE PDF.

Many of the references and guidelines in this document will take you to a website page or PDF. The items on this contents page are hyperlinks to the relevant section.

SECTION 1

CLOTHING & EQUIPMENT

2023/24



CONTENTS

- 3 CLOTHING FOR RUGBY**
- 5 FOOTWEAR FOR RUGBY**
- 9 PROTECTIVE EQUIPMENT**
- 13 SPORTS GOGGLES & EYEWEAR**

THIS IS AN INTERACTIVE PDF.

Many of the references and guidelines in this document will take you to a website page or PDF. The items on this contents page are hyperlinks to the relevant section.

CLOTHING FOR RUGBY



There is a vast amount of different clothing, footwear and protective equipment available to buy. While most items are suitable, it is important to be aware that all clothing and footwear worn during any rugby activity should comply with World Rugby (WR) regulations.

The RFU works closely with World Rugby to ensure that clothing and footwear is safe and appropriate for use while training and playing. Before buying any clothing, especially more bespoke items, it is important to check that it is compliant and can be safely worn during any rugby activity.

It is the responsibility of the manufacturer /retailer to ensure the item is compliant; this can sometimes be evidenced with a World Rugby approved label. In general, most major brands ensure that their products are compliant, however not all clothing is appropriate when participating in contact rugby activity.

Detailed information on clothing and specification can be found in World Rugby's [Law 4 and Regulation 12](#).

This essential guide provides information and recommendations for clothing. Please see the [Protective Equipment Essential Guide](#) for specific information on wearable protective equipment items such as mouthguards, headguards and shoulder pads. For information on other player welfare related topics please visit the [RugbySafe home page](#).



WR approved clothing label



BASE LAYERS

Upper body base layers are allowed in both adult and age grade rugby, provided the design and material complies with the criteria set out in World Rugby Regulation 12.

Both adult and age grade players are permitted to wear base layers leggings/tights, provided they comply with the WR regulation.

Tights are listed as a recognised additional item of clothing for women for modesty and religious reasons; these must be cotton blend long tights, with a single inside leg seam and be worn under shorts and socks.

CLOTHING FOR RUGBY



FINGERLESS MITTS

Fingerless mitts (not gloves) may be worn, providing the coverage of the fingers and thumbs is no further than the outer joint. The mitt coverage should not continue beyond the wrist. These standards are set out by World Rugby and state that the body of the mitt should be of a stretch type material with the grip material being made of a soft rubber/synthetic compound not exceeding a depth of 1mm. No part of a mitt should contain buttons or potentially dangerous items.

Full finger gloves provided they are safe with no buttons etc. may be appropriate for use in non-contact formats of the game. However, they are not permitted for use in contact rugby



HEADSCARVES & RELIGIOUS HEAD-DRESS

Headscarves and other religious head-dress can be worn, providing they do not cause a danger to the wearer or other players and do not contravene **Regulation 12**. Any pins or metal/rigid fasteners should be removed.



BANNED ITEMS OF CLOTHING

World Rugby's **Law 4** sets out a number of items of clothing that are banned.

A player may not wear:

- > Any item contaminated by blood
- > Any sharp or abrasive item
- > Jewellery
- > Gloves
- > Communication devices
- > Shorts with padding sewn into them
- > Any item that is normally permitted in law but, in the referee's opinion, is liable to cause injury
- > Any items containing buckles, clips, rings, hinges, zippers, screws, bolts or rigid material or projection not otherwise permitted under this law.

FOOTWEAR FOR RUGBY



BOOTS, STUDS & BLADES

It is important that suitable footwear is worn when participating in any rugby activity. The most appropriate footwear will depend on the type of activity and playing surface. In most cases, for training and matches it is recommended that a specifically designed rugby/football type boot is worn.

The following Essential Guide provides information and advice on the wearing and use of boots, studs (including blades). However, the large variation of boots and studs means that the information should only be used as guidance. The final responsibility is with the players/parents to ensure that boots and studs are appropriate and safe to play in.

Replaceable studs, blades and moulded boots are allowed, provided that they comply with World Rugby specification set out in **Law 4 and Regulation 12**.

The RFU continues to work with World Rugby and the British Standards Institute (BSI) to ensure safety standards are appropriate. The current standard for boots is **BS6366:2011**.

Boot manufacturers have to self-certify their studs or blades against World Rugby **Regulation 12**. Most commonplace manufacturers meet these standards when designing rugby specific boots. However this is not always the case, some boot manufacturers label and sell boots as “rugby boots” yet the studs are not compliant with World Rugby regulations. However, an illegal boot can quickly become legal with an appropriate pair of studs and vice versa. There is no allowance for any differences based on age or boot-size. Children’s boots should still have studs that comply with the stud criteria. It is therefore advisable to carry out checks before buying new boots or replacement studs/blades.

WHAT TO LOOK FOR WHEN BUYING NEW BOOTS OR REPLACING STUDS/BLADES

Q: What should the stud/blade be made of?

Replaceable studs/blades are usually made from metal, nylon plastic or a combination of both. Full plastic replaceable studs/blades are not suitable as they tend to burr more easily. Studs/blades made of metal or a metal/plastic combination are acceptable, however they should be regularly checked as they can become sharp/burred.

Materials used in replaceable studs/blades should be capable of repeated fixing and removal without damaging the stud or boot or creating a hazard, such as not tightening sufficiently.

Moulded rubber multi-studded boots are fine providing they have no sharp edges or ridges.

FOOTWEAR FOR RUGBY



Q: What should the stud look like?

Studs and blades can come in many different shapes and dimensions. The “traditional” conical stud is used as the standard shape in which other stud designs are measured against.

Studs must meet the following criteria to comply with World Rugby **Regulation 12** and therefore be suitable and safe for use in rugby union.

1. Must not be longer than 21 mm
2. At least 10mm diameter at the end
3. Have no external projections on its surface except for text or a logo (embossment details must be no more than 0.3 mm)
4. All edges of the studs should be finished smooth and rounded to a radius of not less than 1mm
5. Must not have any burring or sharp edges.

The shape and dimensions of other stud designs should be such that they present **no greater risk of injury to another player than the stud/cleat shown in figure 1.**

The cross-sectional contact area of the stud shown in Figure 1 at a plane 2 mm below the tip is 78 mm². Other studs having the same or greater contact area might be expected to give satisfactory performance dependent on minimum stud/cleat width in any direction.

Remember to check boots and studs regularly.

Boots and studs should be checked regularly by player/parents and as part of a match official’s pre-match routine. They should check that the boots and studs/blades are safe to be worn; that there are none missing, they are suitably tightened and have no sharp edges or burring.

By law, a match official has the power to decide at any time that part of a player’s clothing is dangerous or illegal, this includes boots and studs. The player can be asked to leave the field and must not take part in the match until the item is removed or rendered harmless.

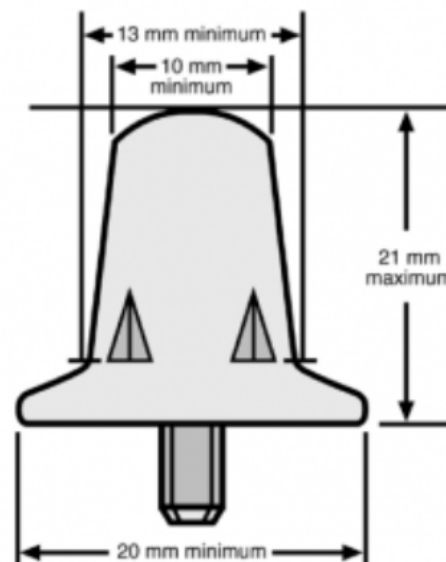

Figure 1

NOTE:

The ultimate responsibility is with the players to ensure that they play in safe boots.

FOOTWEAR FOR RUGBY



EXAMPLES OF LEGAL AND ILLEGAL STUDS AND BLADES

The wide variety of boots, studs, blades, brands and designs available make it almost impossible to cover every single variation. The table below provides some examples of legal, illegal and questionable studs and blades. It is not a definitive list nor does it provide any ‘approval’ for a particular type of stud or blade.

A “legal” stud may be burred or shaped which makes it potentially dangerous and illegal.

METAL STUDS			
			
Legal	Potentially Illegal	Potentially Illegal	Potentially Illegal
<p>Provided no sharp edges or burring.</p> <p>These are the default standard stud against which all others are measured.</p>	<p>The studs look like they might not be \geq than 10mm diameter at the end or suitably rounded as the end is ‘flattened-off’.</p>	<p>The studs look like they may not be \geq than 10mm diameter at the end.</p> <p>It also looks to have non-rounded edges at the tip \geq 1mm</p>	<p>Although the end is of sufficient diameter it looks to have a non-rounded edge at the tip.</p> <p>The requirement for a conical stud is a radius of \geq 1mm.</p>
METAL & PLASTIC COMBINATION STUDS			
			
Legal	Legal	Potentially Illegal	Illegal
<p>Provided they are 1cm at the end and do not have any sharp edges or burring.</p>	<p>Removable plastic/metal stud not exceeding any of the requirements.</p>	<p>It looks to have non rounded edges at the tip \geq 1mm. There is not a sufficient metal ending and is almost 100% plastic.</p>	<p>A completely plastic stud is more likely to burr or shatter.</p>

FOOTWEAR FOR RUGBY

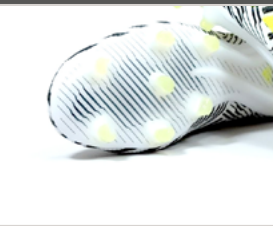

BLADES & GLEATS			
			
Legal	Legal	Illegal	Illegal
Well round metal blades that appear to be replaceable if one was to become burred.	Provided the blade is ≥ 10 mm in diameter and there are no sharp edges or burring.	Very sharp moulded edges that would easily become burred.	These may exceed 21mm in length. The tip is not ≥ 10 mm at the tip nor are the edges rounded ≥ 1 mm.

MOULDED STUDS			
			
Legal	Legal	Potentially Illegal	Potentially Illegal
Provided the moulded stud is ≥ 10 mm diameter, and there are no sharp edges or burring.	Providing they have no sharp edges or ridges.	Less than standard cross-area design, with narrow ridges and the possibility of sharp angles.	The cross-area of these seems less than the 'standard' and the design has a possibility of sharp angles.

PROTECTIVE EQUIPMENT



Before buying any protective equipment especially more bespoke items, it is important to check that it is compliant and can be safely worn while taking part in any rugby activity. All protective equipment worn during any rugby activity must comply with World Rugby regulations.

The Rugby Football Union (RFU) works closely with World Rugby (WR) to ensure that protective equipment is safe and appropriate for use while training and playing.

World Rugby's **Law 4 and Regulation 12** cover wearable protective equipment specifications.

The **World Rugby Approved Protective Equipment Lists** provide information on approved items and suppliers for head guards, shoulder pads and women's protective clothing.



WR approved clothing label

PLEASE NOTE:

It is the responsibility of the participant and manufacturer/retailer to take the necessary measures to ensure the item is compliant; this is often evidenced with a WR approved label.

PROTECTIVE EQUIPMENT



MOUTHGUARDS

The RFU strongly recommends that mouth guards (also referred to as gum shields) are worn for any contact rugby activity (both training and matches). The use of mouthguards can help to protect the teeth and face. However, there is currently no conclusive evidence that mouth guards can reduce the risk of concussion.

It is recommended that mouthguards are custom-fitted. There are alternatives available, such as boil in the bag or pre-moulded mouth guards, which generally provide a reduced level of fit and protection, so this should be a consideration when making a decision on which type to buy.

There is currently no recognised British Standard kite-mark for mouth guards but they are classed as items of personal protective equipment (PPE) and therefore should have a CE mark. This means the mouth guard is compliant with appropriate British and EU testing and standards.

Many dentists will offer a custom-fit mouth guard provision and there are also a number of companies who provide this service. Clubs/schools should ensure that these companies are reputable and provide an appropriate service. In any case, it is important that mouth guards have a CE mark.

Schools and clubs may choose to make the wearing of mouthguards by players compulsory. Where this is the case, they should have a clear policy around checking whether a player may participate if they don't have one available.

HEADGUARDS

Headguards (sometimes referred to as scrum caps) can help to protect the head from cuts and abrasions, and prevent the development of 'cauliflower ears'. Wearing a headguard is permitted on the basis that they should not cause harm or injury to any player and meet World Rugby standards (see **Regulation 12**). However, padded headgear has never been approved or marketed by World Rugby or the RFU to reduce the risk of concussion and there continues to be no conclusive evidence that wearing headguards reduces the chances of sustaining a concussion while playing or training.

Wearing a headguard should be the personal choice of the player and/or parent. While a headguard can provide some protection (e.g. covering the ears) and confidence (e.g. when introducing players to contact); there is a possibility that wearing protective equipment could potentially change a player's behaviour. Therefore, players and coaches are encouraged not to neglect correct technique, particularly in the tackle and ensure that players are aware of the purpose of headguards and their limitations.

PROTECTIVE EQUIPMENT



SHOULDER PADS

Shoulder pads (also referred to as body armour) can help to reduce the impact of a tackle, by absorbing and dispersing the force. They do not increase the power of the tackler in any way.

Shoulder pads are approved by both WR and the RFU and, like all other wearable protective equipment worn during rugby activity, they should be World Rugby compliant (see **Regulation 12**).

There are no mandates set by the RFU on making players wear any specific protective clothing; whether they are worn should be the decision of the player and/or parent. While they can provide some benefit (e.g. absorbing the force) and develop confidence (e.g. when introducing players to contact); there is a possibility that wearing protective equipment can also give a player a false sense of security that can lead to poor tackle technique and potentially change a player's behaviour.

Players and coaches are encouraged not to neglect correct technique, particularly in the tackle and ensure that players are aware of the purpose of shoulder pads (and other similar body armour products) and their limitations.

BREAST PADDING

Specifically designed shoulder pads that include additional breast padding for women are also available on the market. These are acceptable, providing the padding is incorporated as part of a garment where the padding covers the shoulder and/or collar bone and/or chest only. The padding should comprise of a soft/thin material which is compliant with World Rugby **Regulation 12**. Chest padding is not allowed for men.

SHIN GUARDS

World Rugby regulations list shin guards as a permitted additional item, with some restrictions. Shin guards should be worn under the socks, with the padding incorporated within non-rigid fabric. No part of the padding should be thicker than 0.5cm when compressed.

This means that some of the hard plastic football style shin pads may not be suitable for contact rugby. There are brands that specialise in rugby (e.g. Canterbury) with shin guards appropriate for rugby, as they use foam rather than hard plastic.

PROTECTIVE EQUIPMENT



FACE MASKS

Due to the materials used in most protective face masks it is likely they will NOT meet the criteria set out in the World Rugby regulations. There is detailed information that sets out the specifications for any additional items of clothing or protective equipment within WR **Regulation 12**.

If a face mask is to be used the onus is on the manufacturer/retailer to confirm compliance to World Rugby regulations. However previous investigations into face masks have highlighted that something that is soft enough to comply with World Rugby regulations is too soft to provide any significant protection.

In the event that a face mask is found to be appropriate and meets regulation, it is important to consider the long term welfare of the player in the first instance. It is highly recommended that an individual is fully recovered from any injury, or has had full medical clearance to play if they have a permanent condition that requires protection.



OTHER PROTECTIVE ITEMS

All clothing and wearable protective equipment worn during any rugby union activity should comply with World Rugby regulations, rings, hinges, zippers, screws, bolts or rigid material or projection not otherwise permitted under this law

REMEMBER:

Wearing any kind of protective equipment is no substitute for good coaching of safe and correct technique, and players being able to perform this effectively.



BANNED ITEMS OF CLOTHING

World Rugby's **Law 4** sets out a number of items of clothing that are banned.

A player may not wear:

- > Any item contaminated by blood
- > Any sharp or abrasive item
- > Jewellery
- > Gloves
- > Communication devices
- > Shorts with padding sewn into them
- > Any item that is normally permitted in law but, in the referee's opinion, is liable to cause injury
- > Any items containing buckles, clips, rings, hinges, zippers, screws, bolts or rigid material or projection not otherwise permitted under this law.

SPORTS GOGGLES & EYEWEAR



The wearing of spectacles is prohibited for any type of contact rugby activity. However, both prescription glasses and sunglasses are permitted for non-contact activities such as Touch Union and Under 8 and below age grade variations.

Sports goggles may be worn to provide protection e.g. for a medical condition or by a player having lost the sight in one eye and wanting to protect the remaining eye from injury, or to enhance vision where contact lenses can't be worn. This latter situation is often resolved in children, as by the time a child reaches 14 (or shortly afterwards) they may be able to wear contact lenses.

The sports goggles must be dispensed by a registered dispensing optician who is a member of the Association of British Dispensing Opticians (ABDO) or an optician registered with the General Optical Council (GOC).

The player must have written confirmation from the ABDO or GOC optician that:

- > The goggles are required to correct the vision of the player or are required to protect the player's eyes due to a medical or optical condition, to enable the playing of Rugby Union
- > The goggles do not substantially restrict any normal field of vision and are suitable for use in evasion contact sports
- > The goggles do not constitute a physical danger to the player or other players
- > The player is not capable of wearing contact lenses and why this is the case.

The match referee is entitled to object to the player wearing the sports goggles if the referee reasonably believes that they are unsafe.

Last reviewed: August 2023

PLEASE NOTE:

If an optician is registered with the Association of British Dispensing Opticians, the optician will be listed on the General Optical Council's list of registered members which is available at www.optical.org Please check the list by inserting the name of the individual optician or opticians practice.

SECTION 2

FIRST AID PROVISION

2023/24



CONTENTS

- 3 FIRST AID FACILITIES**
- 5 FIRST AID EQUIPMENT**
- 8 FIRST AID TREATMENT**
- 11 FIRST AID WASTE DISPOSAL**

THIS IS AN INTERACTIVE PDF.

Many of the references and guidelines in this document will take you to a website page or PDF. The items on this contents page are hyperlinks to the relevant section.

FIRST AID FACILITIES



Every club and rugby activity organiser should complete a first aid specific risk assessment to determine what facilities are required. It is recommended that a designated first aid room/area is available for training sessions/matches and other rugby activities.

Where possible and practicable, clubs and other rugby activity providers should have a suitable first aid room (or rooms) for use during training and matches.

Wherever possible, the room should be reserved specifically for providing first aid and with a designated individual (e.g. first aid lead or appointed first aider person) being responsible for the room.

The designated first aid room should be easily accessible from the pitch and clearly signposted. **The room should be suitably heated, have good lighting and along with essential first aid facilities and equipment, should ideally include:**



A sink with hot and cold running water.



Drinking water and disposable cups.



Soap and paper towels.



A refuse container.



A secured store for first aid materials.



A container for the safe disposal of clinical waste.



A couch with waterproof protection, clean pillows and blankets.



A chair.



Access to a phone or other communication equipment.

FIRST AID FACILITIES



Where a specific first aid room is not available, the club/ other rugby activity provider should identify an area within the venue that can be suitably adapted and/or set up for the sole use of a designated first aid area during the session, match day or event, e.g. a gazebo or spare changing room, this area should be set up to enable the safe and appropriate treatment of individuals should it be required e.g. protected from bad weather, a safe distance away from playing areas.

The designated first aid area should be easily accessible from the pitch and clearly signposted. The area should ideally include:



A chair.



Access to a phone or other communication equipment.



A secured store for first aid materials.



A refuse container.



A container for the safe disposal of clinical waste.



Clean blankets.

Access to the following should also be available if required:



Access to hot and cold water.



Drinking water and disposable cups.



Soap and paper towels.

FIRST AID EQUIPMENT



Every club, school and other rugby activity providers should complete a first aid specific risk assessment to determine what equipment is required. It is important to have appropriate first aid equipment readily accessible whenever any rugby activity is taking place. The equipment required will be determined by the playing level, type of activity, available facilities and number of participants.

The **RugbySafe First Aid/ Immediate Care Provision Guidelines** provide detailed information on the recommended first aid/immediate care provision and the related roles and responsibilities.

Emergency first aid should only be given by **appropriately trained persons**. Clubs and other rugby activity providers should maintain a list of all trained first aiders with expiration of qualifications recorded in order to make sure re-qualification is organised when required.

The first aid equipment available should be appropriate to the level of training that the first aider or immediate care provider has received. No-one should attempt to use equipment they have not been trained to use.

FIRST AID KITS

All pitch-side first aiders should be appropriately equipped with their own first aid kit and there should be at least one suitably stocked first aid box should also be situated in the club house.

Pitch-side first aid kits should be appropriate for its use, made of suitable material and designed to protect the contents appropriately, It is also recommended that appointed first aiders wear hi-visibility jackets which clearly identifies them as first aiders.

Clubhouse first aid kits should be located in a suitable and safe place based on the nature and size of the venue (more than one kit may be required), they should be readily accessible (e.g. not locked away). Suitable signage should be used to identify the location of first aid kits.

All first aid consumables should be checked frequently to ensure sufficient quantities and that all items are usable. A process should be in place to ensure that the content is replenished as soon as possible after use, and it is recommended that clubs nominate an individual e.g. the Club RugbySafe Lead to take the responsibility for this process across the club.

Some items, particularly sterile ones, are marked with expiry dates. They should be replaced by the dates given and all expired items safely disposed of. In cases where sterile items have no dates, it would be advisable to check with the manufacturers to discover how long they can be kept. For non-sterile items without dates, it is a matter of judgement, based on whether they are fit for purpose.

FIRST AID EQUIPMENT



The following is a recommended list of contents for the pitch-side and clubhouse first aid kits. Quantities will vary depending on need. The kits should be checked regularly and re-stocked as required.

RECOMMENDED FIRST AID KIT CONTENTS

Antibacterial hand gel	Tough cut scissors/shears
Single use triangular bandages	Micropore Tape
Antiseptic wipes	Tweezers
Sterile eye Pads	Sterile wound dressings (individually wrapped, assorted sizes)
Disposable gloves	Safety pins
Sterile Water Pods	Non-Woven Swabs (assorted sizes)
Adhesive plasters (assorted sizes)	Emergency foil blanket or Blizzard Blanket
Resuscitation aids (Face Shields and/or Pocket Mask)	Sterile wound closure strips (assorted sizes)
Adhesive & non-adhesive bandages (assorted sizes)	Clinical Waste bag
Water bottle (for cleaning wounds)	Blister Plasters (assorted sizes)
Adhesive Tape (assorted sizes)	

For more information on first aid consumable items such as petroleum jelly (Vaseline), Ice and Cold/Heat Sprays in First Aid Kits, please refer to the **First Aid Treatment section below**.

Cold/Heat Sprays should not be used on children.

There is a First Aid Kit Checklist template available in **Section 5**.

FIRST AID EQUIPMENT



OTHER FIRST AID EQUIPMENT

SPINAL BOARDS, SCOOPS AND STRETCHERS



Spinal boards and scoops should only be used by those appropriately trained. Emergency First Aiders are in most cases not trained to use spinal boards, scoops or stretchers.

It is recommended that clubs have a folding stretcher available for use by the ambulance services and other appropriately trained individuals if required.

AUTOMATED EXTERNAL DEFIBRILLATOR (AED)

London Hearts is an England wide charity and one of the leading heart charities in the UK for placing defibrillators in communities and delivering CPR and defibrillator training. Working with England Rugby, London Hearts can support clubs, provide guidance on the purchase of defibrillators for rugby clubs who don't currently already have this lifesaving equipment. It also provides support to clubs who already have a defibrillator on site. With every package, London Hearts provides an online CPR and defibrillator training video and ongoing support, including advice on purchasing and maintenance of an AED unit.



London Hearts has internal funding available and can assist you in finding additional funding that may be available for clubs.

For more information please visit the dedicated [London Hearts](#) page.

FIRST AID TREATMENT



ADMINISTRATION OF DRUGS

Under **no** circumstances should any prescription or non-prescription (including paracetamol and aspirin) drugs be administered by first aiders or kept in a first aid kit. Players (and/or parents) should take personal control of and responsibility for the administration of any required medication.

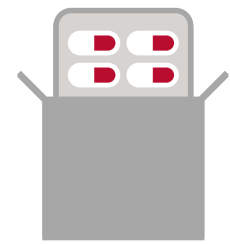

Personal medications should be clearly labelled and stored separately from team first aid kits.

Schools may have their own policy that differs to this, such as permission to hold pupil medications on the premises.



PETROLEUM JELLY

Petroleum jelly (e.g. Vaseline) can be used as part of the wound management process. It is important that this is done correctly, ensuring that the wound is cleaned and then dressed appropriately. As contamination is the main concern it should only be applied using methods preventing contamination, such as a single use spatula.

It can also be used by players to protect sore feet, prevent blisters etc. In this case players should have their own supply. If petroleum jelly is stocked in a first aid kit, it should only be used for first aid purposes.

ICE / COLD TREATMENT

Applying ice to a suspected injury is technically providing therapy which is not the role of a first aider. There is a growing body of research questioning the effectiveness of ice treatment, suggesting that applying ice to most injuries does not improve recovery. However, the NHS continues to recommend cold treatments for example **PRICE** (Protection, Rest, Ice, Compression and Elevation) as an early intervention for some injuries such as a suspected sprain and bruising.

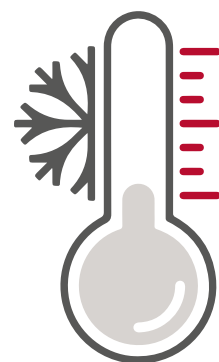

Therefore it may be appropriate to give players ice to self-treat an injury. Actual ice is more effective (and cheaper) than ice packs, as many ice packs don't get cold enough to have the desired effect.

It is important to be aware of the potential for ice burn. A damp cloth/towel should always be placed between the ice and the skin to provide protection. Ice sprays are not advised for use in this situation.

FIRST AID TREATMENT



In general, ice can be used as a safe treatment to reduce pain levels in the short term and it is unlikely to have a negative effect in the long term when used in a sensible and appropriate manner.

ICE CAN HELP:

- > Reduce bleeding into the tissues
- > Reduce swelling (inflammation)
- > Reduce muscle pain and spasm
- > Reduce pain by numbing the area and by limiting the effects of swelling
- > Reduce stiffness.

DO NOT USE ICE:

- > If there is a suspected concussion
- > Over areas of skin that are in poor condition
- > Over areas of skin with poor sensation to heat or cold
- > Over areas of the body with known poor circulation
- > If the individual has diabetes
- > In the presence of infection
- > On the left shoulder if the individual has a heart condition
- > Around the front or side of the neck.

As ice can numb the pain and potentially mask an injury, it is recommended that if a player has received an injury requiring the application of ice, there should be consideration as to whether it is appropriate for the player, especially if a child, to return to play immediately.

The NHS provides information on how to treat generic sports injuries such as sprains and strains, visit the [NHS Sport Injuries Treatment page](#) for more information.

HEAT TREATMENT

Heat **should not be used on a new injury** as it can increase bleeding and the blood flow around the injured area and may make the problem worse.

Heat treatment **should not** be used on an injury that is swollen or inflamed.

Heat is sometimes used by therapists as an effective and safe treatment for some aches and pains; **however heat treatment should not be used as a first aid intervention.**

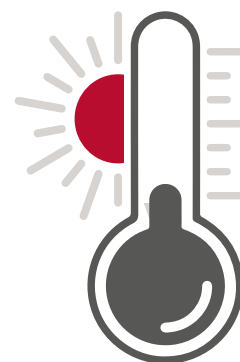

FIRST AID TREATMENT



FURTHER INFORMATION

The NHS provides comprehensive health information and guidance. Call 111 for non-emergency medical advice or visit the [NHS website](#).

NOTE:

Any advice provided by the RFU in relation to specific injuries, illnesses or disabilities is only general advice and it should not be used as a substitute for the individual advice patients receive when they consult their own doctor. Individuals are advised to consult their own General Practitioner or Hospital Consultant for specific advice on their condition and/or fitness to train for or play rugby.

FIRST AID WASTE DISPOSAL



Extra care must be taken when cleaning up of blood or other bodily fluids such as vomit, as they can pose a serious health risk to anyone who might come into contact with them if not cleaned up appropriately and safely.

General steps for safe clean up and disposal:

- > Personal Protective equipment (PPE)
- > Cleaning procedures for contaminated area
- > Personal decontamination
- > Safe and appropriate disposal or sanitisation

PERSONAL PROTECTIVE EQUIPMENT (PPE)

First Aids should wear PPE as standard practice, however when cleaning up the main risk from bodily fluids is infection following hand to mouth, nose or eye contact during clean up. There is also a risk of infection via broken skin. Anyone cleaning up and disposing of blood and other bodily fluids should use appropriate PPE.

- > Waterproof and abrasion-resistant gloves (e.g. nitrile gloves)

Protective gloves should be worn when handling waste. Avoid touching anything else when you have the gloves on and are dealing with infectious substances/materials.

- > Other PPE: Eye protection, disposable plastic apron, waterproof disposable shoes covers

Depending in the circumstances, the use of the PPE should be considered, as any part of the body or clothing that could come into contact with bodily fluids should be covered. This is especially important if you have any open wounds (even a tiny cut on your hand). Properly dress wounds with sterile plasters or bandages.

Cleaning procedures for contaminated area:

- > Isolate the area – use a Warning A-board or cones to mark the affected areas.
- > Safely remove any potentially infectious substances and/or materials
- > Use suitable cleaning substances such as a bleach, disinfectant cleaning product, hot water and an absorbent powder if available and appropriate.
- > Thoroughly clean the affected area, surfaces and equipment to ensure they are appropriately disinfected and/or sterilised.

FIRST AID WASTE DISPOSAL



Personal decontamination

Once the clean-up is completed, the safe removal and disposal/sanitisation of PPE is important to ensure you don't contaminate yourself.

- > Wash your hands with your gloves still on in hot soapy water if visibly contaminated, and dry with a disposable towel.
- > With your gloves still on, remove any other PPE e.g. apron, taking care to avoid touching your skin or clothing whilst doing so.
- > Wash and dry your hands with the gloves on with hot soapy water a second time.
- > Remove the gloves by peeling them off from the inside to out.
- > Wash your bare hands thoroughly once all contact with potentially contaminated PPE and infectious substances/materials are disposed of.

Safe and appropriate disposal or sanitisation

The club/venue should have a process in place for the disposal of potentially infectious substances/materials and contaminated PPE.

In cases where there is a small amount of contaminated waste and/or only lightly soiled materials, it is generally seen as practical and acceptable to use the standard domestic refuse/waste disposal. However it is essential that all the waste and PPE is wrapped up securely within absorbent material e.g. paper towels, double bagged and then placed deep within a domestic refuse collection bin/container.

Larger amounts of contaminated waste, heavily solid materials and some cleaning products should be placed in biohazard or clinical waste bags. These should not be mixed with your regular refuse/waste. The local council or a waste disposal contractor should be contacted. Many waste disposal contractor who collect sanitary waste will also collect biohazard or clinical waste.

Dispose of all the PPE in the same way as the other infectious waste. Any reusable PPE must be thoroughly cleaned and disinfected or sterilised using appropriate products and methods.

Any contaminated materials, such as bedding or clothing, should also be bagged separately for laundry or disposal. If soiled clothes are laundered, this should be done as a separate load.

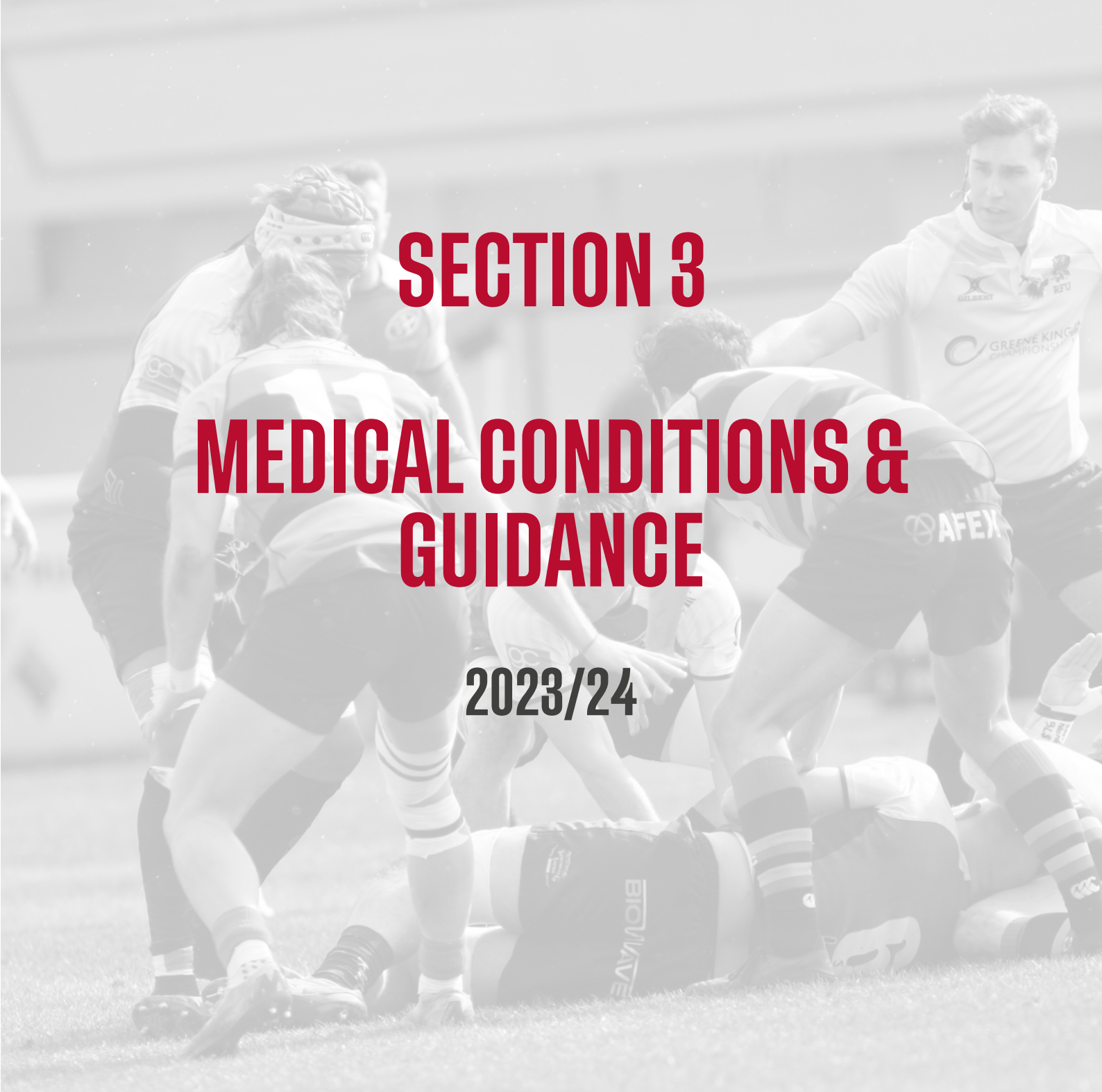

SECTION 3

MEDICAL CONDITIONS & GUIDANCE

2023/24



WWW.ENGLANDRUGBY.COM

CONTENTS

3	MEDICAL CONDITIONS - GENERAL INFORMATION
4	ASTHMA
6	BLEEDING DISORDERS
7	CEREBRAL PALSY
8	DENTAL TRAUMA
10	DIABETES
11	DOWN'S SYNDROME
12	EPILEPSY
14	PROSTHETIC LIMBS
15	MANAGING SKIN ABRASIONS
19	LINKS & RESOURCES

THIS IS AN INTERACTIVE PDF.

Many of the references and guidelines in this document will take you to a website page or PDF. The items on this contents page are hyperlinks to the relevant section.

GENERAL INFORMATION



Participation in physical activity can have many positive effects. For most people exercising and participating in sports such as rugby provides many benefits, improving fitness and wellbeing, increasing energy levels and helping to relieve stress. However, for people with certain medical conditions, participating in strenuous exercise and contact sports such as rugby may not be appropriate.

The RFU recommends that anyone with a medical condition that may be affected by strenuous exercise, or the physical nature of a sport like rugby, should seek medical advice before participating in any rugby union activity. The decision on whether an individual can play rugby and in what format (e.g. contact, touch rugby) needs to be on the basis of medical advice by an appropriate expert.

It is recommended that anyone over 45 who hasn't been taking part in regular activity should see their GP for advice before taking part in any high intensity activity.

If under 18 then the player's parents/carers should be asked by the club or school to confirm in writing that their child has been medically cleared to play. An adult player should also inform their club, with a record being kept.

Where considered appropriate for an individual to participate, good communication between the player, parent/carer(s), coaches, referees and other key personnel is important. Everyone is then clear as to what, if any, specific accommodations should be taken to consider safety and ensure that the experience is a positive one for the player and others involved. Coaches should consider using different methods and approaches that meet the needs of the individual and the group of players they are working with.

ASTHMA

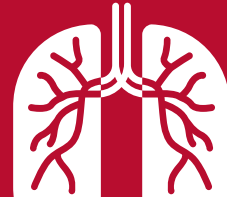

Asthma is often seen as a reason not to exercise or play sports. Yet for most people with asthma, particularly children, exercise and sport are good for their condition.

Rugby union can play a positive part in getting people involved in activity and leading a healthier lifestyle. However, it is important to ensure that the asthma is well controlled and that players and coaches etc. have a clear understanding of any limitations, and know what to do if symptoms occur and in the event of an asthma attack.

Coaches are sometimes worried about working with players (especially children) with asthma as they are concerned about its effects, the use of medicines and the risk of a flare up of symptoms or an asthma attack. In most cases this is completely manageable and awareness of some simple considerations will allow players to participate as much as they are able.

One of the main worries for players with asthma is the effect of cold air which can cause the muscles around the airways to tighten and make breathing more difficult. To minimise the effect of cold air ensure that everyone is appropriately warmed up and, if necessary, that individuals have taken their inhaler beforehand.

TIPS TO MANAGE ASTHMA WHILE PLAYING RUGBY

1. Coaches should make sure they know **which players have asthma**
2. Always start sessions with **progressive warm up exercises**
3. Try to **avoid the things that trigger asthma symptoms** (e.g. smoke, pollen)
4. Ensure that players always have their **blue reliever inhaler** with them
5. If a child has asthma symptoms when they are playing, ensure that they **stop, use their inhaler** (preferably with a spacer if they have one) and wait five minutes or until they feel better before starting again. An adult player should monitor their own symptoms and be aware of whether they need to leave the pitch
6. If a player has to sit out, try to **involve them as much as possible**. For example by getting them to take notes on the match or training, or getting them to do some simple rugby activities such as passing (if they feel well enough)
7. Always end sessions with **warm down exercises**
8. If a player is having any problems during a rugby session **always let their parents know**, as they may need to visit their doctor or asthma nurse for an asthma review
9. Players should ideally have a **written management plan**. This is especially important while playing rugby and is a reminder for the player and those around them about what to do if they are experiencing severe asthma symptoms.

Before participating in any rugby union activity, a player with asthma should book an asthma review with their GP or asthma nurse to check their asthma is well controlled and that they're not using their blue inhaler more than twice a week. Clubs/schools should keep a record of any players with asthma, with coaches, team managers etc. checking before every session that the player has access to their inhaler.



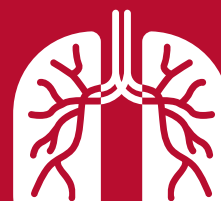

ASTHMA







Where deemed appropriate to participate, communication between the player, parent/carer(s), coaches and first aiders is important so that everyone is clear of what, if any, particular precautions need to be taken to keep the individual safe during rugby games or training.

Asthma UK provides the following guidance for when an adult or child is having an asthma attack:

IF A CHILD IS HAVING AN ASTHMA ATTACK

-  1: Help them to sit up – don't let them lie down. Try to keep calm
-  2: Help them take 1 puff of their reliever inhaler (usually blue) every 60-90 seconds, up to a maximum of 10 puffs.
-  3: **Call 999 for an ambulance if:**
 - > their symptoms get worse while they're using their inhaler - this could be a cough, breathlessness, wheeze, tight chest or sometimes a child will say they have a 'tummy ache'
 - > they don't feel better after 10 puffs
 - > you're worried at any time
-  4: If the ambulance has not arrived within 10 minutes, repeat step 2.

WHAT TO DO IN AN ASTHMA ATTACK

-  1: Sit upright (do not lie down) and to remain calm.
-  2: Take 1 puff of your reliever inhaler (usually blue) every 30 to 60 seconds, up to a maximum of 10 puffs.
-  3: **Call 999 for an ambulance if:**
 - > you do not have your inhaler with you
 - > you feel worse despite using your inhaler
 - > you do not feel better after 10 puffs
 - > you're worried at any point
-  4: If the ambulance has not arrived within 10 minutes, repeat step 2.

This asthma attack advice is not designed for children or adults using a MART medication plan. Speak to your GP or asthma nurse to get the correct asthma attack information.

Last reviewed: August 2023

USEFUL INFORMATION AND LINKS

Further information and the latest advice about asthma is available at **Asthma UK**.

Asthma UK Helpline is a dedicated help line with a team of expert asthma nurses available to speak to confidentially on 0300 222 5800. Opening times Mon-Fri 9am-5pm.

BLEEDING DISORDERS



CAN SOMEONE WITH A BLEEDING DISORDER PLAY RUGBY?

Participating in rugby union activity can have benefits for many people, including improving physical fitness, and having a positive effect on psychological and emotional wellbeing. However, for some individuals with certain medical conditions it may not be appropriate to participate. For individuals with bleeding disorders (and especially with more severe haemophilia) contact rugby would not be appropriate.

The **National Haemophilia Foundation** provides recommendations on what type of physical activity individuals with moderate and more severe blood disorders should and should not take part in (see below for Playing it Safe Bleeding Disorders Sports and Exercise resource).

If deemed appropriate to play rugby, players with mild bleeding disorders should identify the safest ways to participate in any rugby activity and communicate these to the coaches and first aiders / immediate care providers involved with their rugby sessions. There is then a clear process for dealing with any bleeds, ensuring that they are detected and treated quickly. In some cases, touch rugby and other non-contact formats of the game may be a more appropriate alternative for individuals with mild conditions.

Before participating in any rugby union activity an individual with a bleeding disorder should take advice from a specialist. If under 18 then the player's parents/carers should provide the club and/or school with written confirmation that their child has been medically cleared to play. An adult player should also inform their club, with a record being kept. Players should be dealt with on an individual basis, with advice being taken from the player, their parents and a specialist.

Coaches should consider using different methods and approaches which meet the needs of the individual. For example, allowing longer gaps for particular individuals between activities or regular time outs to enable them to check for any issues. It is important that there is communication between the player, parent/carer(s), coaches, first aiders and other key personnel so that everyone is clear what, if any, precautions need to be taken.

Last reviewed: August 2023

USEFUL INFORMATION AND LINKS

The Haemophilia Society have further information and guidance on bleeding disorders.

Further guidance on sport participation is available from the **National Haemophilia Foundation** in their **Playing it Safe, Bleeding Disorders Sports and Exercise** resource.

CEREBRAL PALSY



CAN SOMEONE WITH CEREBRAL PALSY PLAY RUGBY?

There is a vast variation in the way cerebral palsy may affect different individuals and participation in physical activity can have diverse effects for people with cerebral palsy. For a few, participating in strenuous exercise and a contact sport may not be appropriate. However, for others exercising and participating in sports such as rugby provides many benefits, improving fitness and wellbeing, increasing energy and relieving stress levels.

Before participating in any rugby union activity an individual with cerebral palsy should seek medical advice, particularly in relation to the risk of concussion. Due to the variations in cerebral palsy, advice may be required on one or more aspects of the condition and the side effects it may present. The decision on whether an individual can play rugby, and in what format, therefore needs to be based on the medical advice given by an appropriate expert. If under 18 then the player's parents/carers should be asked by the club or school to confirm in writing that their child has been medically cleared to play. An adult player should also inform their club, with a record being kept.

Where deemed appropriate for an individual to participate, communication between the player, parent/carer(s), coaches and first aiders is important so that everyone is clear of what, if any, precautions need to be taken to keep the individual and other players safe during rugby games or training. Coaches should consider using different methods and approaches that meet the needs of the individual. If contact rugby is not advised, touch or tag rugby may be an appropriate alternative. The **International Mixed Ability Sports** organisation promote the development of inclusive activity including mixed ability rugby.

Last reviewed: August 2023



USEFUL INFORMATION AND LINKS

For information on cerebral palsy please go to **Cerebral Palsy Sport**.

UK Coaching offer training opportunities and resources to support those involved with coaches, including some useful **tips for coaching disabled people**

The **Activity Alliance** works to make people with a disability active and engaged in sport.

The **International Mixed Ability Sports** organisation promotes the development of inclusive activity including mixed ability rugby.

DENTAL TRAUMA



The risk of dental trauma in rugby union is very low* when appropriate preventative measures are taken (such as wearing a mouthguard). However, it is important to be aware of these preventative measures and what to do if a dental injury occurs.

The following guidance provides players, first aiders, coaches etc. with important information on how to prevent injuries and what to do if a dental injury occurs.

It is highly recommended that anyone participating in a contact sport such as rugby union wears a properly fitted and custom mouth guard as this can minimise the risk of injury. More information on mouthguards can be found in **Section 1 - Clothing and Equipment**.

It is especially important that children wear mouth guards to prevent injury which may result in long-term dental treatment. In general (outside rugby activity), dental trauma is most common in 7 - 14 year olds, especially to the front teeth in boys. This can have a dramatic impact on tooth development, requiring extensive complex treatment. It is important to keep the mouth guard up to date and fitting well as the child grows, especially if the child wears dental braces.



SAVE A KNOCKED OUT TOOTH

PICK IT
Keep calm!
Find the tooth and **PICK IT** up holding the crown only.

LICK IT
Clean the mouth with water and mop up any blood.
If the tooth is visibly dirty, **LICK IT** or pour water over it.

STICK IT
Gently **STICK IT** back into position and bite down on a tissue to keep it in place.

PICK IT, LICK IT, STICK IT!
and go to a dentist immediately.
If you are unable to replant a tooth, put it in milk and go to the dentist immediately.
Never replant a baby tooth.

www.dentaltrauma.co.uk | @dentaltraumauk | facebook.com/groups/dentaltraumauk

PICK IT. LICK IT. STICK IT

This document has been produced in collaboration with **Dental Trauma UK** a charity set up to promote the best way to save injured, damaged or knocked out teeth as a result of trauma..

Additional information and a number of useful free resources are available from the **Dental Trauma UK** website, such as this flashcard which can be downloaded, printed and used in first aid kits and notice boards etc.

USEFUL INFORMATION AND LINKS

For information please visit the Research section on the **RugbySafe** page.

* Taken from the RFU Community Rugby Injury Surveillance and Prevent Project (CRISP) data collected between 2009 - 2020.



WHAT TO DO IF A TOOTH IS KNOCKED OUT? DON'T PANIC!

Step 1:

PICK the tooth up by the crown only (do not touch the root).

Step 2:

If possible get player to **LICK** their own tooth clean if it is dirty, or rinse it with water.

Step 3:

STICK the tooth back in position (adult teeth only).

NEVER try to re-insert a baby tooth.

Step 4:

Get the player to bite on a clean handkerchief or bandage to hold it in place.

Step 5:

Go straight to a dentist (or A&E if out of hours).

If it's not possible to put the tooth back in position, put the tooth in milk and go straight to a dentist (or A&E if out of hours).

BROKEN OR CHIPPED A TOOTH?

Tooth fragments can sometimes be glued back into position.

Find the fragment and take it to the dentist who might try to re-position re-build it with a tooth-coloured filling.

Last reviewed: August 2023

DIABETES



CAN SOMEONE LIVING WITH DIABETES PLAY RUGBY?

Physical activity, such as playing rugby, can have positive effects for people living with diabetes. Improving fitness and wellbeing, increasing energy levels and relieving stress can help an individual manage their diabetes.

Participating in exercise can help increase the amount of glucose used by the muscles for energy, so it may sometimes lower blood glucose levels. It can also enable the body to use insulin more efficiently, and potentially reduce the amount of insulin that people have to take, providing benefits to both type 1 and type 2 diabetics.

Before participating in any rugby union activity, an individual with diabetes should seek medical advice. If under 18 the player's parents/carers should be asked by the club or school to confirm in writing that their child has been medically cleared to play. An adult player should also inform their club, with a record being kept. In all cases it is important that there is communication between the player, parent/carer(s), coaches and first aiders so that everyone is clear what, if any, precautions need to be taken to manage insulin/blood sugar levels during rugby games or training.

CAN SOMEONE WITH AN INSULIN PUMP PLAY RUGBY?

It is advisable to seek medical advice before participating in any rugby union activity. The player/parent/carer(s) should speak with their specialist to explain exactly what activities they will be undertaking and follow the advice given.

It may be possible for the player to remove the pump and secure and protect the indwelling catheter to enable them to participate. This must be confirmed by the player's diabetes nurse, who will be able to advise on the best way to do this, as well as confirming if it is indeed possible with the particular device used by the individual. They should also advise on what other arrangements need to be made, given that the individual would be undertaking prolonged activity without the delivery of insulin.

It is important to consider the potential damage that may be caused to the device, as well as the potential for injury that the device (particularly if broken) could cause to the individual or another player in a contact rugby situation - the World Rugby regulations do not allow any rigid materials on the rugby pitch for this reason (see World Rugby **Law 4**) so it may be necessary to talk to their medical specialists about the activities undertaken in more detail.

Last reviewed: August 2023



USEFUL INFORMATION AND LINKS

For further information on diabetes please visit **Diabetes UK**.

DOWN'S SYNDROME



CAN SOMEONE WITH DOWN'S SYNDROME PLAY RUGBY?

The way that Down's Syndrome can affect individuals varies a great deal and participation in physical activity can have differing effects. For an individual with Down's Syndrome and spinal involvement, we would recommend that they don't participate in contact sport as the risk of injury is significantly increased.

For these individuals Touch rugby, on the advice of their specialist, may be a more viable option. However, for others contact rugby may be acceptable, with exercise and participation in rugby providing many benefits, such as improving fitness and wellbeing.

Before participating in any rugby union activity an individual with Down's Syndrome should seek medical advice, particularly in relation to the risk of concussion. Due to the variation in Down's Syndrome, advice may be required on one or more aspects of the condition.

The decision on whether an individual can play rugby, and in what format, needs to be on the basis of medical advice by an appropriate expert. If under 18 the player's parents/carers should be asked by the club or school to confirm in writing that their child has been medically cleared to play. An adult player should also inform their club, with a record of the decision being kept.

Where considered appropriate for an individual to participate, good communication between the player, parent/carer(s), coaches, referees and other key personnel is important so that everyone is clear what, if any, safety accommodations are taken and to ensure that the experience is a positive one for the player and others involved. Coaches should consider using different training methods and approaches that meet the needs of the individual and the group of players they are working with.

Last reviewed: August 2023

USEFUL INFORMATION AND LINKS

For further information please visit the [Down's Syndrome Association](#).

UK Coaching offer training opportunities and resources to support those involved with coaches, including some useful tips for coaching disabled people.

The **Activity Alliance** works to make people with a disability active and engaged in sport.

The **International Mixed Ability Sports** organisation promote the development of inclusive activity including mixed ability rugby.

EPILEPSY



CAN SOMEONE LIVING WITH EPILEPSY PLAY RUGBY?

Many people with epilepsy are able to manage their condition through medication and lead a normal life. Participation in physical activity can have differing effects for people with epilepsy.

For a few, strenuous exercise can increase the likelihood of a seizure occurring, but for many, exercising and participating in sports such as rugby provide many benefits including improved fitness and wellbeing, increased energy levels and stress relief. All of which can contribute to a reduction of seizures and the impact of epilepsy.

There is huge variation in how epilepsy and any medication can affect people and each case should be dealt with on an individual basis.

IMPORTANT:

Before participating in any rugby union activity an individual with epilepsy should seek medical advice from an appropriate specialist, particularly in relation to the risk of head impacts and concussion.

If under 18 then the player's parents/carers should be asked by the club or school to confirm in writing that their child has been medically cleared to play. An adult player should also inform their club, with a record being kept. If epilepsy has been caused by a head injury then playing contact sport is generally not advised, and touch or tag rugby may be an appropriate alternative.

Where considered appropriate for an individual to participate, good communication between the player, parent/carer(s), coaches, first aiders and other key personnel is important so that everyone is clear what, if any, precautions are taken to prevent or manage any seizures should they occur during rugby games or training. Coaches should consider using different methods and approaches to ensure that the experience is a positive one for the player and others involved.

Last reviewed: August 2023

USEFUL INFORMATION AND LINKS

More information and further guidance is available from the [Epilepsy Society](#).

HEARING IMPAIRMENTS & HEARING AIDS



CAN INDIVIDUALS WITH A HEARING AID STILL PLAY RUGBY?

Recognising the benefits of rugby such as improving fitness and wellbeing, the RFU aims to be inclusive as possible, however player welfare must come first and so we have to bear in mind the risk of injury to the player wearing the aid and to other players from contact with the device or broken devices.

Hearing aids are not specifically set out as banned items of equipment. However, they must comply with the requirements as set out in **World Rugby's Law 4 and Regulation 12**. Where possible we recommend that hearing aids are removed prior to playing, or taking part in any contact activity; but we understand that this may not always be practical.

The decision on whether a hearing aid can be worn for rugby activity (including contact) will depend on the specification of the hearing device. For example, a moulded, modern-day version is more likely to comply with the WR **Regulation 12** requirements and unlikely to present any issues. It may, therefore, be appropriate for a moulded hearing aid to be worn, although we'd suggest a head guard/scrum cap is also worn.

Touch rugby may be an appropriate alternative when contact activity is not suitable and for any individuals with cochlear implants fitted, where contact sports aren't advised due the risk of damaging the device and potentially causing further issues.

It is advised that the player/parent/carer(s) speaks with their specialist before participating in any rugby union activity. They should discuss what activities they will be undertaking and follow advice. If under 18 then the player's parents/carers should be asked by the club or school to confirm in writing that their child has been medically cleared to play. An adult player should also inform their club, with a record being kept.

In such cases, good communication between the player, parent/carer(s), coaches, referees and other key personnel is important. Everybody should be clear on what, if any accommodations need to be taken to consider safety and ensure that the experience is a positive one for the player and others involved.

Coaches can use different methods to meet the needs of the player, for example the hearing-impaired player having a 'buddy' to help with instructions or know when the whistle is blown.

Last reviewed: August 2023



USEFUL INFORMATION AND LINKS

UK Deaf Sport provides further information on the opportunities in sport for the deaf and individuals with a hearing impairment. See more useful resources in the **Links & Resources** page.

PROSTHETIC LIMBS



CAN SOMEONE WITH A PROSTHETIC LIMB(S) PLAY RUGBY?

It may be possible for someone with a prosthetic limb(s) to play rugby, depending on the type of prosthetic worn and the proficiency of its use.

Consideration needs to be given as to whether the prosthetic limb would be appropriate and safe for rugby, both for the individual and others playing around them. It is recommended that before participating in any rugby activity the player/parent(s) consult their local prosthetic department to seek expert advice on whether it would be appropriate for the individual to play and whether the current prosthetic limb is suitable and safe. In some cases it may be possible to develop a prosthesis that meets the requirements and regulations.

Blades, for example, would not be acceptable, whereas a simulated limb with appropriate levels of protection may meet the requirements and there have been cases where prosthetic departments have been able to develop something that meets the requirements in World Rugby's **Regulation 12** and the individual has been able to participate in contact rugby.

World Rugby's **Law 4 and Regulation 12** covers "**Provisions Relating to Players' Dress**" this includes the specification of any materials such as the depth of foam padding etc. which are allowable to reduce the risk of injury, these specifications set out in **Regulation 12** also apply to the materials used in prosthetic limbs and will determine whether it can be worn while participating in rugby activity.

Touch rugby may be a suitable alternative for individuals where contact rugby has not been advised, however it is important that the appropriate specialist advice is taken before participating in any activity. Appropriate footwear and/or type of traction fitting of the prosthetic would also need to be considered.

If deemed safe and appropriate to play, the club/school should get written confirmation from the player's prosthetic consultant/department stating that the limb is viable for playing rugby, and doesn't pose an increased risk of injury to either the player or others. Last reviewed: August 2023

USEFUL INFORMATION AND LINKS

Limb Power provide information and support for amputees and individuals with limb impairments looking to engage in physical activity and sport.

UK Coaching offer training opportunities and resources to support those involved with coaches, including some useful tips for coaching disabled people.

The Activity Alliance works to make people with a disability active and engaged in sport.

MANAGING SKIN ABRASIONS



During prolonged periods of hot and dry weather, rugby players playing on both natural turf and artificial grass are likely to be more susceptible to skin abrasions.

IMPORTANT:

This essential guide outlines the RFU recommendations on how best to minimise the incidence of these abrasions and how to manage them when they do occur.

WHO GETS SKIN ABRASIONS?

In the 15-a-side game skin abrasions are most common in wingers, centres and flankers. In the 7s game, because it is faster, all players are equally at risk of getting abrasions.

WHICH PART OF THE BODY IS MOST AFFECTED?

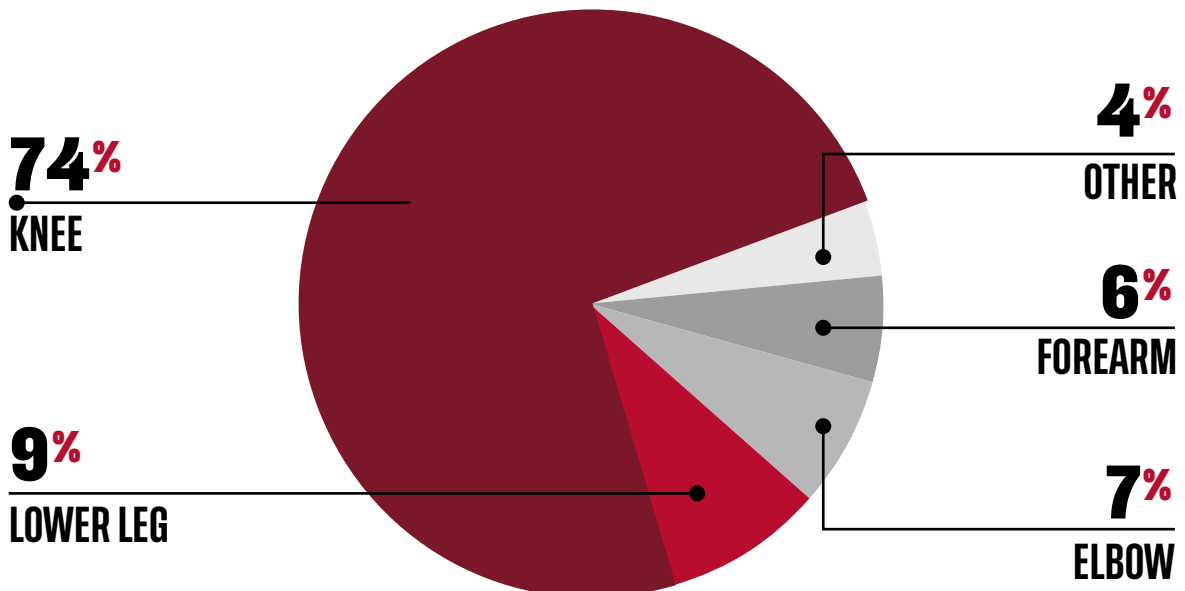

MANAGING SKIN ABRASIONS



TYPES OF ABRASION

1st degree abrasion

Injury to the outermost layer only. The skin is pink/red and mildly painful. These injuries are no more than a nuisance and usually heal in under a week.

2nd degree or abrasion

Injury involves the deeper layers of the skin. These are more painful because of exposed nerve endings. There is usually some bleeding at the wound site initially that later gives way to a clear fluid discharge which soils clothes and bed sheets if left unattended. This is the most common skin injury and typically dismissed, despite its potential for complications, such as an infection or scarring.

3rd degree abrasion

Involves all layers of the skin down to where the subcutaneous fat is exposed and/or there is skin loss. This is rare in rugby.

PREVENTION

1. CLOTHING

Covering up exposed skin at greatest risk reduces the incidence and severity of skin abrasions:

- > Long sleeve shirts or base layers
- > Long trousers or base layers
- > When playing in shorts, ensure socks are fully pulled up to cover as much of the lower-legs as possible.



2. SKIN BARRIERS

Application of petroleum jelly/paraffin such as Vaseline™ to at-risk areas reduces frictions with the surface. Repeated application may be needed over the course of a game.

3. ENVIRONMENTAL

If possible, ask the groundsman to use some kind of irrigation on the pitch or training area prior to activity, if it is considered to be harder and/or drier than normal.



MANAGING SKIN ABRASIONS



TREATMENT

While large 2nd degree and all 3rd degree injuries should be seen by a healthcare professional most 1st and small 2nd degree wounds can be self-managed.

1. CLEAN THE WOUND

1. Make sure the wound is clean of any dirt and debris from the playing surface.
2. Wash the area with soap and warm running water for at least 20 seconds.
3. If needed, gently clean the area with medical gauze from the first aid kit.
4. If the wound is heavily contaminated and cannot be cleaned because it is too painful and/or debris is buried too deeply, seek medical help.



2. COVER WITH A DRESSING

Do not leave abrasions uncovered to dry out or scab over. This practice is no longer encouraged because it increases the risk of infection, scarring and re-injury. Keeping the area moist encourages the wound to heal almost twice as fast than if a scab is allowed to form.

1st degree abrasions can be simply dressed with an antiseptic ointment/cream readily available over the counter. Moisturise the area regularly to prevent light scabbing.

The skin is typically back to normal in 5-7 days.

2nd degree abrasions should have a moisture retaining dressing layer like paraffin gauze placed directly over them before covering with a non-adherent, absorbent dressing.

Larger abrasions, particularly around the lower leg or thigh, can weep heavily for the first couple of days and a thick absorbent dressing may be needed.

MANAGING SKIN ABRASIONS



INFECTION

Infections can occur when abrasions are not managed appropriately, so it is important to recognise the signs of an infected wound:



Increasing pain



Increased redness around the wound edges or the surrounding skin



Presence of pus, yellow discharge or abscess formation



Increase/worsening odour



Slow healing wound.

IMPORTANT NOTE:









If you suspect a wound infection see your doctor or attend your local minor injuries unit as soon as possible.

It is important to also ensure that you/the player are up to date with tetanus vaccination.

Last reviewed: August 2023

LINKS & RESOURCES



	<p>NHS</p>
	<p>Activity Alliance</p>
	<p>Asthma UK</p>
	<p>Cerebral Palsy Sport</p>
	<p>Deaf Sport (UK)</p>
	<p>Dental Trauma UK</p>
	<p>Diabetes UK.</p>
	<p>Down's Syndrome Association</p>
	<p>Epilepsy Society</p>

LINKS & RESOURCES



 THE HAEMOPHILIA SOCIETY	The Haemophilia Society
 NATIONAL HAEMOPHILIA FOUNDATION <i>for all bleeding disorders</i>	National Haemophilia Foundation Playing it Safe, Bleeding Disorders Sports & Exercise
 INTERNATIONAL MIXED ABILITY SPORTS	International Mixed Ability Sports
 Limb POWER <i>Living life without limbs</i>	Limb Power
 UK COACHING	UK Coaching Useful tips for coaching disabled people

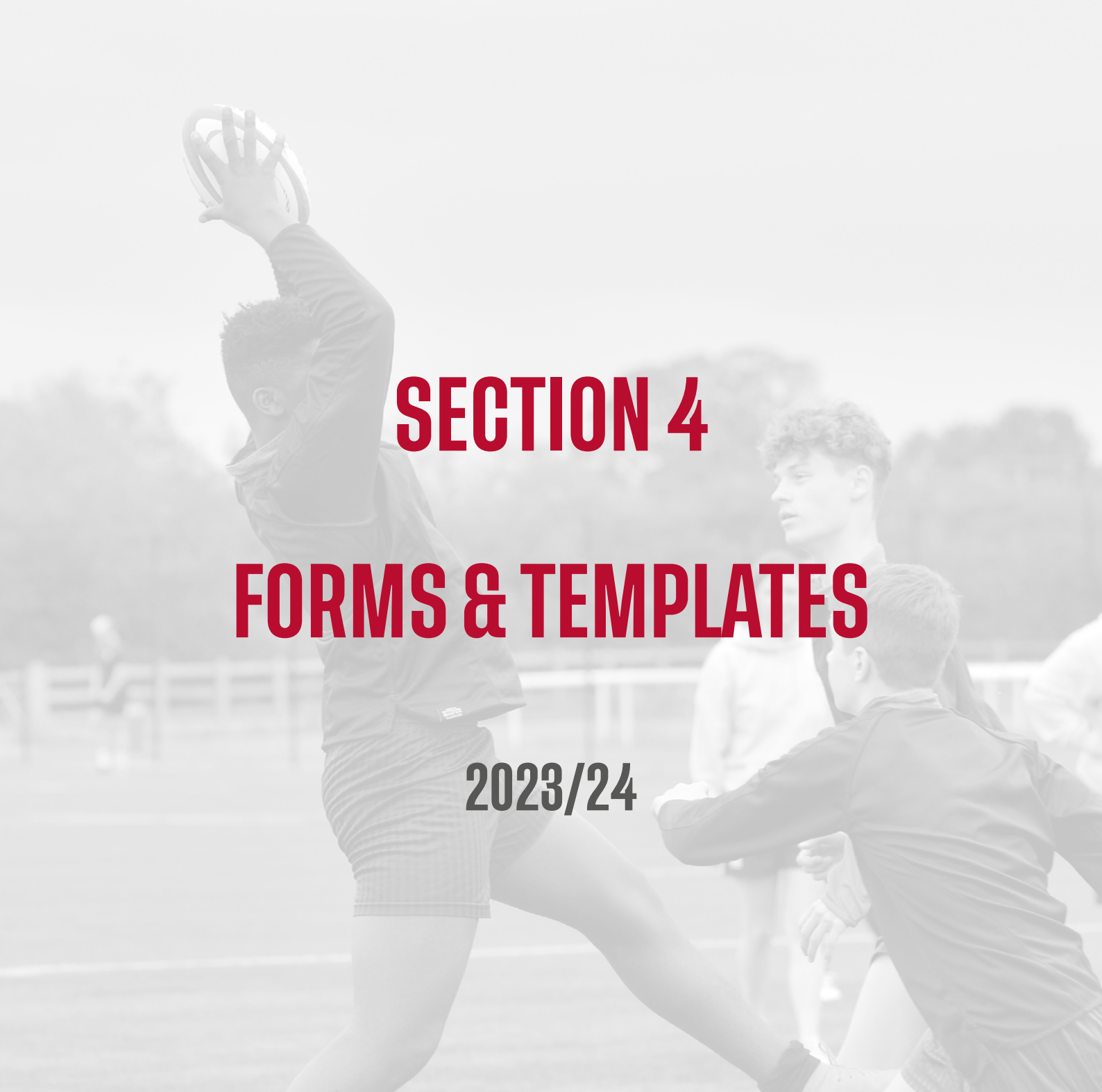

SECTION 4

FORMS & TEMPLATES

2023/24



CONTENTS

- 3 RFU REPORTABLE INJURY EVENT REPORT FORM**
- 4 REFEREE RFU REPORTABLE INJURY EVENT REPORT FORM**
- 5 MEDICAL EMERGENCY ACTION PLAN TEMPLATE**
- 7 INJURY/INCIDENT REPORT FORM**
- 9 RUGBYSAFE CHECKLIST**

FIRST AID CHECKLIST (PDF)

THIS IS AN INTERACTIVE PDF.

Many of the references and guidelines in this document will take you to a website page or PDF. The items on this contents page are hyperlinks to the relevant section.

RFU REPORTABLE INJURY EVENT REPORT FORM

Please use this form to report any injuries whilst playing rugby or taking part in organised rugby squad training sessions that fit any of the following definitions:

1. An injury which results in the player being admitted to a hospital.
2. Deaths which occur during or within 6 hours of a game finishing.

Date of report:		Date of injury:	
Player's name:		DoB or age:	
Club/School etc.		Team:	
Nature of suspected injury:			
Category:			
<ol style="list-style-type: none"> 1. An injury which results in the player being admitted to a hospital. 2. Deaths which occur during or within 6 hours of a game finishing. 			

Injured player contact details

Player's contact number:			
Additional contact (e.g. Next of kin) name:			
Relationship to player:		Phone number:	

Please submit as much of the following information as you can, as soon as possible following the incident.

The RFU uses this data for contacting individuals (via the RFU Injured Players Foundation) and/or their clubs who are identified as requiring immediate support in the case of a potentially catastrophic injury. Information regarding the circumstances of injury may be used anonymously to monitor injuries throughout the game. Further information is available in the privacy policy at [IPF website](#).

Game	Training	Grass	Artificial grass	Other surface
Was there (please select)				
Appropriate first aid in place?		Yes	No	
Any alleged foul play relating to the injury event?		Yes	No	

GAME INJURIES ONLY

Opposition Club/School etc.:		Team:	
Name of Referee:		Venue:	

Name of reporting person:	
Position within Club/School etc.:	
Contact telephone number	

Once completed, please send this form to: RFU Sports Injuries Administrator:
sportsinjuriesadmin@rfu.com or report by phone on 0800 298 0102

It is important that the referee records the event whilst it is clear in his/her mind. If the referee has any concerns about completing the report or requires assistance, he/she should not hesitate to contact either the local Society secretary or the RFU Match Official Development Manager, Michael Patz at michaelpatz@rfu.com.

Home Team:		Away Team:	
Name of Home Team Captain:		Name of Away Team Captain:	
Name of Home Team Coach:		Name of Away Team Coach:	
Date of Match:		Level of Match:	
Factual Summary of Incident (please use your "own words" and do not include speculation, opinion or guesswork)			
Was the match card submitted to the Referee Society?	Yes	No	
Touch Judges' Names (if applicable):			
Name(s)/contact details of First Aid / Immediate Care staff attending:			
Name(s)/contact details of spectators who witnessed the incident:			
Referee's Name:		Date of report:	
Phone No:		Email:	

Please submit one copy of the completed report to your Referees Society Secretary (retain for 6 years) and one to the RFU Sports Injuries Administrator via email sportsinjuriesadmin@rfu.com or post to Sports Injuries Administrator, Rugby Football Union, Rugby House, Rugby Rd, Twickenham, TW1 1DS.

If the referee receives any communications from third party lawyers, these should be sent directly to his/her local society and emailed to the RFU Legal Department via legal@rfu.com. The injured party's advisors will often approach various sources seeking to obtain information such as the Club, individuals, the Referees' Society and/or the referee, and therefore any correspondence or telephone calls received from lawyers representing injured parties should be referred to the RFU's Legal Officer.

The information in this plan should be shared with all coaches/teachers and relevant volunteers as well as all visiting teams.

Club/School/College/ University Name:	
MEAP for: (e.g. Adult matches, age grade matches days etc.)	
Address & Postcode:	
Sat Nav Postcode / Additional location details for Emergency Services:	
MEAP Lead (main contact):	
RugbySafe Lead / First Aid Coordinator (if different from above):	
Age Group/ Team First Aiders	
Name	Contact Number
Ambulance Access Point	
Pitch Side	
First Aid Room	
Club House	
First Aid Equipment Location	
First Aid Kit	
Defibrillator (AED)	
Stretcher (for use by trained individuals only)	
Other Equipment	

Location of Local Hospitals/Services

Accident & Emergency

Minor Injuries

Pharmacy

MEAP Chain of Command & Procedures

Other Relevant Information

In the event of a Medical Emergency call the Emergency Services as quickly as possible on 999/112 giving as many details as possible.

Please note this is an Injury/Incident template for club use. Any RFU Reportable Events must be reported using the correct **RFU Reportable Event Form**.

Please see the **Proactive App** for an online option for a Injury/Incident Reporting process.

		Ref:	
About the person who had the incident/injury			
Full name:			
Address:			
Postcode:		Age (if under 18)	
Activity being undertaken at time of incident/injury:			
About the person reporting the incident/injury			
Full name:			
Address:			
Postcode:		Age (if under 18)	
Role:			
Signed:		Date:	
About the incident/injury - When and where			
Date it took place:		Time:	
Where it took place (room or location)			
About the incident/injury - What happened?			
How did the incident/injury happen?			
What was the cause?			

**If there were any injuries, what were they?
(Use diagram to indicate location and potential type injury)**

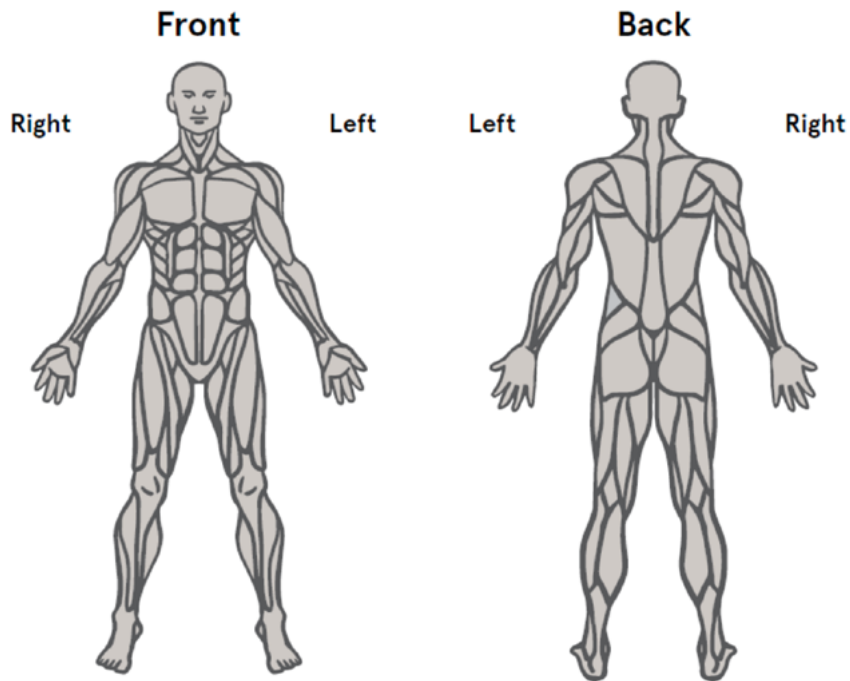

Additional Information

Blank area for additional information.

Action taken

Ambulance called	Yes	No
Taken to hospital	Yes	No
Advised to seek further medical attention	Yes	No
Player/parent signature:	Date:	

All clubs, schools, colleges, universities and other rugby activity organisers, should work towards the following **10 Steps to Being RugbySafe:**

1	Have a Club RugbySafe Lead in place, who is in contact with the CB RugbySafe Lead.	
2	Take a club's RugbySafe responsibilities seriously and meet the Regulation 9 requirements	
3	Complete and regularly update the RugbySafe & Player Welfare GMS Page.	
4	Complete and record a first aid specific risk assessment to determine the appropriate level first aid provision required for training, matches and other rugby activity.	
5	Complete, share and regularly review a Medical Emergency Action Plan.	
6	Ensure suitable First Aid and/or Immediate Care provision, facilities and equipment are in place for all Training & Matches.	
7	Integrate Activate injury prevention programme into all training sessions and match preparations.	
8	Have procedures in place for the recording and reporting of injuries and incidents and know what an RFU Reportable Event is.	
9	Have a process in place for coaches, referees, players and parents to complete the HEADCASE concussion online module.	
10	Create a kinder culture and promote positive wellbeing within the club.	



SECTION 5

USEFUL LINKS

2023/24



USEFUL LINKS



Activate - Injury Prevention Exercise Programme



Anti-Doping & Illicit Drugs



Coaching Disabled People



Coaching People with Learning Difficulties



Food for Rugby



HEADCASE



Injured Players Foundation



Insurance



London Hearts



Mental Health & Wellbeing



Proactive Injury Reporting



Research



Risk Assessment Tool



Safeguarding



Training Course Booklet



Transgender



World Rugby Player Welfare



[ENGLANDRUGBY.COM/RUGBYSAFE](https://www.englandrugby.com/rugbysafe)



[FACEBOOK.COM/RUGBYSAFERFU](https://www.facebook.com/rugbysaferfu)



[@RUGBYSAFE](https://twitter.com/RUGBYSAFE)